

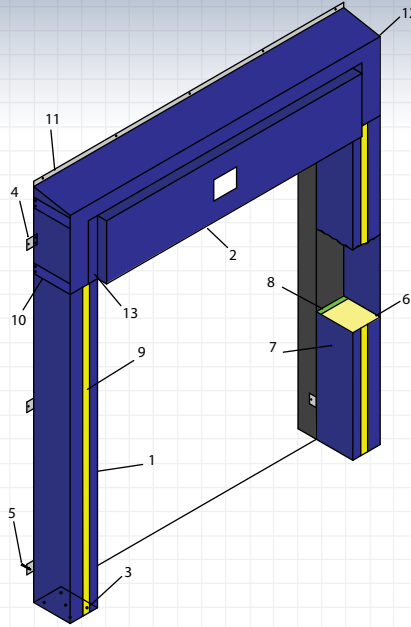

## Series 0251 Product Details:

- Series 0251 standard dimensions for door openings 8' W x 10'H are two (2) 10'H vertical pads with a 12" face, cube shaped, and one (1) 10'L x 24" drop head curtain with foam pad insert. Foam pad insert dimensions are, 4" deep x 24" H x 96" L. Unit projection to be 10".
- Seal trailers 12' to 13'6" H from grade with dock height of 48".
- A large selection of cover fabrics available includes our exclusive SS-90-1 high performance vinyl. Other fabrics available include: hypalons and vinyls. (see Material Selection Guide).
- Can be fitted for openings up to 10' W x 10' H by the use of wedge shaped vertical pads and a longer drop curtain.
- 4" to 6" maximum pad projection in front of the dock bumper face is recommended to prevent over compression, excessive wear and tear, and undue building wall pressure.



1. Vertical pads
2. Head curtain with foam pad insert
3. Air vents
4. Galvanized steel mounting brackets
5. 3/8" sleeve anchor bolts
6. Polyurethane foam core
7. Cover fabric
8. Pressure treated wood backing
9. 4" yellow guide stripe
10. Head curtain restraining straps
11. Steel curtain retaining bar
12. Steel tube
13. Inside retaining strap

## Specifications:

Dock door seal(s) SERIES 0251FP to be manufactured by Super Seal Mfg. Ltd., Woodbridge, Ontario. Dock door seal(s) to be manufactured to fit door opening size(s) \_\_\_\_\_ Ft. W x \_\_\_\_\_ Ft. H. Vertical pads to be manufactured using select pressure treated wood, and a high density, light weight urethane foam core with 98% compression recovery and maintaining flexibility at -40°. The foam core is continuously bonded (not spot glued) to the wood backing with a high quality, non-flammable elastic adhesive. Cover fabric shall be double stitched with high strength twisted 4-ply 100% polyester bonded thread U.V. treated. The cover fabrics overlaps the wood backing, totally enclosing it, and is fastened with heavy duty plated staples. Vertical pads are vented through air venting holes, allowing air to be exhausted and moisture to drain. Vertical pads are tapered cut at the bottom to prevent sagging, pinching, and wearing when compressed, as well as the top to provide adequate draining. Vertical pads have a 24" high 4" yellow guide stripe to aid in spotting trailers. Unit shall come complete with a matching full width curtain over vertical pads. A full width steel tube shall be inserted into a pocket of the head curtain to prevent sagging. The head curtain to have a 4" D x 18" H x required Length urethane foam pad wrapped in a polyethylene sleeve and inserted into a specially constructed pocket on the face of the curtain. Unit shall be furnished with all necessary mounting hardware, galvanized to resist corrosion.

## Options:

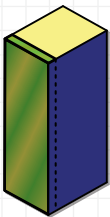

A. Cover material overlaps edges only

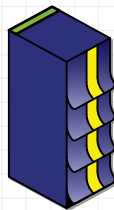

B. Protective flaps (4", 8" & 16" exposure)

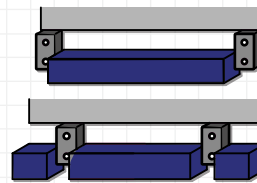

C. Bottom pads

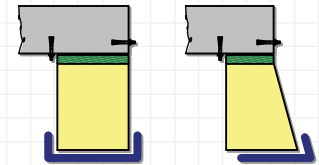

D. Double layer of material on impact areas

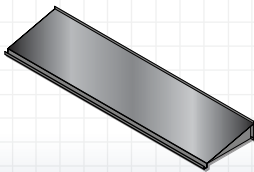

E. Galvanized steel canopy

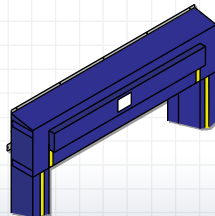

F. Split curtain

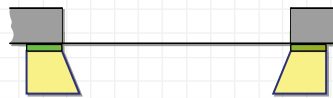

G. Bevelled vertical pad

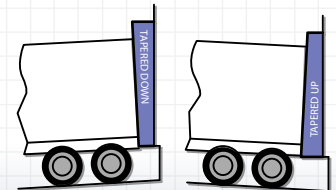

H. Tapered units



DEALER IMPRINT



Custom Designs Available!

\*\* All Super Seal products are subject to design modifications without notice. Product may be shown with non-standard options.